

Personnel safety, light screen
Emitter
SLPE14-410P8

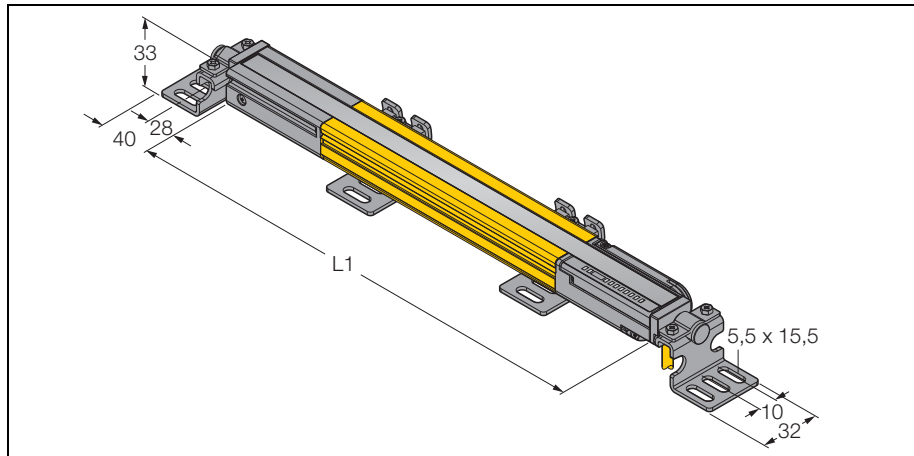

- Personnel safety category PLe acc. to ISO 13849-1
- Category 4 according to EN 945-1, or type 4 according to IEC 61496-1, -2
- SIL 3 to IEC 61508
- Flat housing without blind zone
- Adjustment of scan code via DIP switch
- Resolution 14 mm
- Sensing height 410 mm
- Operating voltage 24 VDC +-15%
- Electrical connection, M12 x 1 male, 8-pole (QDE-8..D)
- Degree of protection IP65

Type	SLPE14-410P8
Ident-No.	3083541
Operating mode	light screen
Light type	IR
Wavelength	850 nm
Optical resolution	14 mm
Range	0... 7000 mm
Detection zone height	410 mm
Ambient temperature	0...+ 55°C
Operating voltage	20... 28 VDC
No-load current I ₀	≤ 32 mA
Response time	< 13.5ms
Housing	rectangular, EZ-Screen LP
Dimensions	26x 28x 410mm
Housing material	Metal, AL
Lens	plastic, acrylic
Electrical connection	cable with connector, M12 x 1
Protection class	IP65
Operating voltage	LED green
Switching state	2-color LED red

Wiring diagram

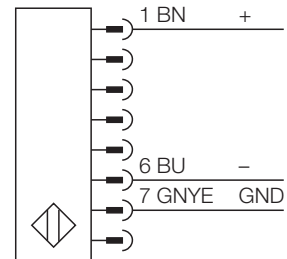

Functional principle

The high-resolution safety light curtain is emitter and receiver in one without blind zone. As the system is synchronized optically, wiring between emitter and receiver is redundant. The safety switching outputs of the receiver are directly connected to a load relay (e.g. IM-TA9A) and trigger an immediate stop of the dangerous machine cycle. The switching device with 2-channel monitoring, diverse redundant designed and mutual processor control, complies with the personnel safety category PLe acc. to ISO 13849-1.