

**light screen for machine safety applications**  
**emitter**  
**SLSE14-1650Q8**

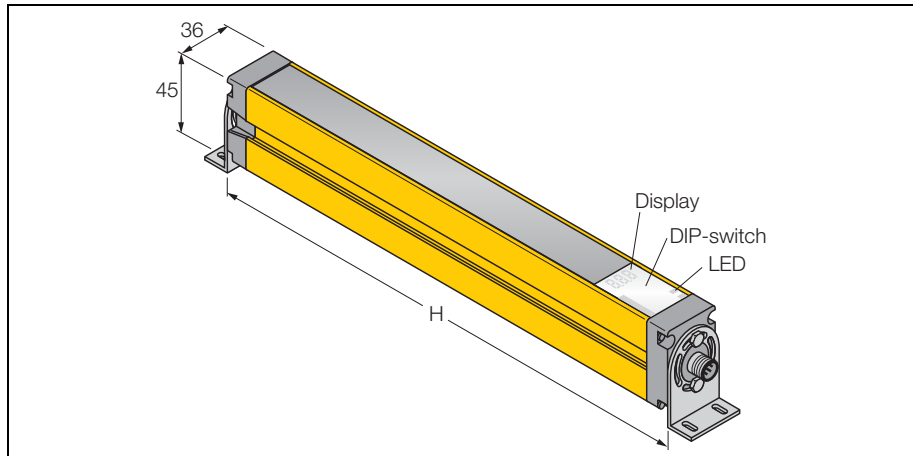

- Personnel safety category PLe acc. to ISO 13849-1
- Category 4 according to EN 945-1, or type 4 according to IEC 61496-1, -2
- SIL 3 to IEC 61508
- adjustment via DIP switch
- male connector, M12 x 1, 8-pole
- resolution 14 mm
- detection zone height 1,650 mm
- operational voltage 24 VDC +15%
- degree of protection IP65

**Wiring diagram**

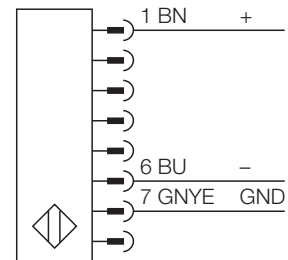

**Functional principle**

The high-resolution personnel safety light screen consists of an emitter and a receiver. As the system is synchronised optically, emitter/receiver wiring is redundant. The safety switching outputs of the receiver are directly connected to a load relay (e.g. IM-TA9A) and trigger an immediate stop of the dangerous machine cycle. Personnel safety degree type 4 according to IEC 61496 is fulfilled due to 2-channel monitoring of the switching device and the diverse redundant construction with mutual processor control.

<b>Type</b>	SLSE14-1650Q8
Ident-No.	3073361
<b>Operating mode</b>	light screen
Light type	IR
Wavelength	950 nm
Optical resolution	14 mm
Range	100... 6000 mm
Detection zone height	1650 mm
Ambient temperature	0...+ 50°C
<b>Operating voltage</b>	20... 28 VDC
Response time	< 52ms
<b>Housing</b>	rectangular, EZ-Screen
Dimensions	45x 36x 1719mm
Housing material	Metal, AL
Lens	plastic, acrylic
Electrical connection	Connectors, M12 x 1
Protection class	IP65
<b>Operating voltage</b>	LED green